

Original version of the operating instructions

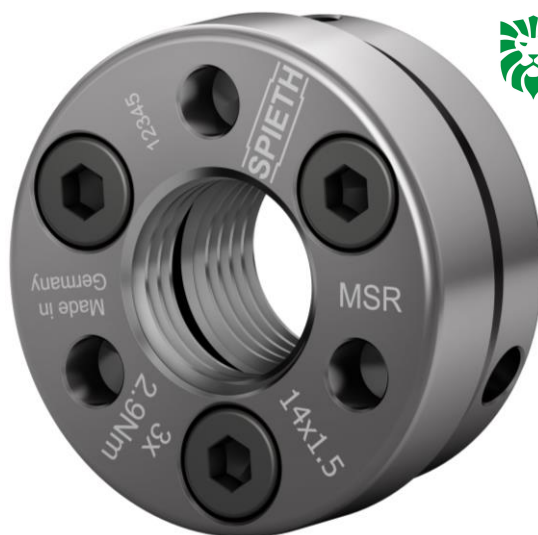

For	Series	Components
Spieth locknuts (precision locknuts)	MSR from M10 to M55	MSR 10x0.75; MSR 10x1; MSR 12x1; MSR 12x1.5; MSR 14x1.5; MSR 15x1; MSR 16x1.5; MSR 17x1; MSR 18x1.5; MSR 20x1; MSR 20x1.5; MSR 22x1.5; MSR 24x1.5; MSR 25x1.5; MSR 26x1.5; MSR 28x1.5; MSR 30x1.5; MSR 32x1.5; MSR 35x1.5; MSR 38x1.5; MSR 40x1.5; MSR 42x1.5; MSR 45x1.5; MSR 48x1.5; MSR 50x1.5; MSR 52x1.5; MSR 55x1.5; MSR 55x2

The Operating Instructions are also available for download at www.spieth-me.de. In case of any questions, please contact Spieth-Maschinenelemente GmbH & Co. KG directly.

Legal:

Spieth-Maschinenelemente GmbH & Co. KG, Alleenstraße 41, D - 73730 Esslingen
 Phone +49 711 930730 0 - Fax +49 711 930730 7
 E-Mail: info@spieth-me.de - Web: www.spieth-me.de

KG: Esslingen HQ, Stuttgart county court, company register sect. A 210689
 PhG: Spieth-Beteiligungs-GmbH, Esslingen HQ, Stuttgart county court, company register sect. A 210636
 Managing director: Dipl.-Ing. Alexander Hund

©Spieth	Previous document: ba-msrk-en1604	See
Proprietary notice	Successive document: N/A	www.spieth-me.de/english/service-download/catalogue-instructions/
ISO 16016	Created: 13 Apr 2018/Fd	For any questions, requests or suggestions, please contact
	Checked: 13 Apr 2018/Ax	info@spieth-me.de

About the operating instructions for Spieth Locknuts

These operating instructions enable safe and efficient handling of Spieth locknuts. Prior to performing any tasks, ensure that your staff have carefully read and fully understood these operating instructions.

Notices

The basic requirement for working safely is compliance with all specified safety notices. They can be identified by the following symbols:

Caution!

In addition to the notices in these instructions, local accident prevention guidelines and national health and safety regulations also apply.

Table of Contents

1	Information about Spieth Locknuts	3
1.1	General information	3
1.2	Safety notices	3
2	Description of Spieth Locknuts	4
2.1	Structure	4
2.2	Mode of action	4
2.3	Intended use	5
3	Delivery Contents and Storage of Spieth Locknuts	6
3.1	Delivery contents of the Spieth Locknuts	6
3.2	Storage and shelf life of the Spieth Locknuts	6
4	Assembling Spieth Locknuts	6
4.1	Preparing for assembly	6
4.2	Ambience/Environment	7
4.3	Assembly process	7
5	Using Spieth Locknuts.....	9
6	Disassembling Spieth Locknuts.....	9
7	Disposing of Spieth Locknuts.....	10

Document Fehler! Verweisquelle konnte nicht gefunden werden.1815 Page 3 of 11	<h1>Operating Instructions</h1> <h2>MSR from M10 to M55</h2>	 SPIETH Aus Prinzip präziser
--	--	---

1 Information about Spieth Locknuts

1.1 General information

Please read these operating instructions carefully, paying special attention to our safety notices. These operating instructions are part of your product and must be kept accessible to the staff in the immediate vicinity of the product at all times. The operating instructions are also available for download at www.spieth-me.de.

In case of any questions, please contact Spieth-Maschinenelemente GmbH & Co. KG directly.

Caution!

It is mandatory to comply with the recommendations and notices in these operating instructions.

Inform the end user about the contents of these operating instructions.

Spieth-Maschinenelemente GmbH & Co. KG assumes no liability for damage caused by (i) misinterpreting or nonobserving the operating instructions; (ii) improper use; (iii) incorrect installation or unauthorised structural changes; or (iv) incorrectly circulating or failure to circulate the contents of these operating instructions to third parties.

These operating instructions apply on the assumption that the chosen product is valid for the use case. Please see the related design guide (available at www.spieth-me.de) for specifications, characteristics, and information on choosing the right Spieth locknuts.

1.2 Safety notices

Spieth locknuts are intended for use on threaded spindles. Please follow all relevant safety notices.

Caution!

Any work carried out with or on the locknut needs to follow the "safety first" guideline!

During operation, keep your hands away from the working area of the locknut!

Prior to any assembly work, switch off all machine drives!

Secure the machine against accidental power-up!

Prior to commissioning the machine, install all safety devices!

Only expert personnel are allowed to perform assembly work on Spieth locknuts. Using Spieth locknuts is only admissible according to specifications. Spieth-Maschinenelemente GmbH & Co. KG assumes no liability for violations of the operating instructions or safety notices. This also applies to incorrectly interpreting or circulating these notices and to incorrect assembly or maintenance.

©Spieth	Previous document: ba-msrk-en1604	See
Proprietary	Successive document: N/A	www.spieth-me.de/english/service-download/catalogue-instructions/
notice	Created: 13 Mar 2018/Fd	For any questions, requests or suggestions, please contact
ISO 16016	Checked: 13 Mar 2018/Ax	info@spieth-me.de

The locknuts described here are state of the art at the time these assembly instructions are printed. Subject to changes based on evolved technologies. For international deliveries, follow the safety regulations applicable in the target country.

2 Description of Spieth Locknuts

2.1 Structure

- Spieth locknut bodies
- Spieth clamping screws
- Radial boreholes for pin spanner DIN 1810 - B
- Axial boreholes for face spanner

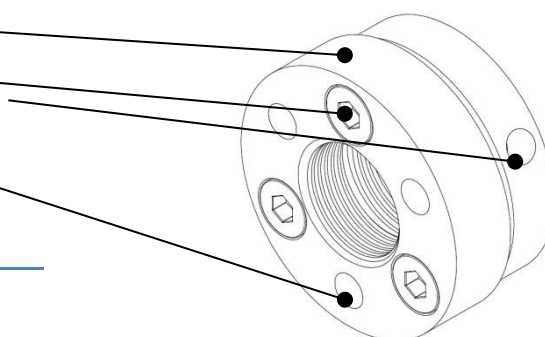

Identifying features (for original Spieth locknuts)

Spieth logo

Name

Batch number

Locking torque M_s for clamping screws

Fig. 1: Schematic representation similar to Spieth MSR series locknuts

Spieth MSR series locknuts are assemblies consisting of locknut bodies and clamping screws. The thread inside the locknut body is interrupted by a groove, separating the locknut body into a load and a locking part. A diaphragm connects load and locking part.

2.2 Mode of action

Spieth locknuts are precision locknuts. Due to their design they provide a maximum of precision, combined with utmost locking properties.

Spieth MSR series locknuts have been designed as all-purpose precision locknuts (e.g., for locking high-quality fastenings, shaft bearings, or spindle bearings).

Despite their compact design and the high axial loads occurring here, Spieth-locknuts guarantee permanent pretension and a rigid and precisely aligned contact with the bearing for an immaculately supported spindle.



Fig. 2: Illustration similar to Spieth MSR locknuts

©Spieth	Previous document: ba-msrk-en1604	See
Proprietary	Successive document: N/A	www.spieth-me.de/english/service-download/catalogue-instructions/
notice	Created: 13 Mar 2018/Fd	For any questions, requests or suggestions, please contact
ISO 16016	Checked: 13 Mar 2018/Ax	info@spieth-me.de

Document Fehler! Verweisquelle konnte nicht gefunden werden.1815 Page 5 of 11	<h1>Operating Instructions</h1> <h2>MSR from M10 to M55</h2>	 SPIETH Aus Prinzip präziser
--	--	---

Spieth MSR series locknuts are frictionally engaged one-piece locknuts. Load part and locking part of the locknut body approach each other purely along an axis via the elastic diaphragm. Actuating the tensioning / clamping screws arranged in axial direction causes load part and locking part to approach each other purely along an axis. Since the locking part has been designed as a stable ring, a 360° tessellation using several thread turns is used to achieve a frictionally engaged clamping on the shaft thread. Tessellation converts the bolt force directly into a contact force evenly distributed across the entire circumference. Owing to system characteristics, this automatically aligns the end face at a right angle.

2.3 Intended use

Spieth locknuts are recognised state of the art. They have been designed to permanently retain pretension and/or a position on a threaded spindle using frictional locking in the thread. Any other usage is regarded as improper use.

Spieth-Maschinenelemente GmbH & Co. KG reserves the right to technical changes. In case of any questions or technical issues, please contact Spieth-Maschinenelemente GmbH & Co. KG.

Caution!

Only expert personnel are allowed to choose, assemble, operate, and service Spieth locknuts.

Use Spieth locknuts only according to product-specific specifications. To ensure proper functioning of the Spieth locknuts, it is mandatory to comply with the specifications of the connecting components. Detailed information on the above items can be found in the Design Guide. Operating conditions, e.g. speeds and temperatures at which the Spieth locknuts are used must not exceed common standards.

Caution!

The user assumes responsibility for proper spindle thread design, for ascertaining the pretension required for the bearings to be locked, for determining the operating loads and meeting permissible operating conditions. In case of any questions or technical issues, please contact Spieth-Maschinenelemente GmbH & Co. KG.

In case operating conditions change, it is mandatory to check if the locknut is still suitable for further use.

Spieth locknuts need to be handled with care, assembled correctly, and used as intended to achieve their full functional potential. Prior to working with our locknuts, please read these operating instructions carefully. In particular, please follow all relevant safety notices.

Caution!

It is mandatory to comply with the instructions for use and the general safety notices!

Handle locknuts with care before and during assembly and assemble them according to these operating instructions. Use only stipulated tools for assembling locknuts.

©Spieth	Previous document: ba-msrk-en1604	See
Proprietary	Successive document: N/A	www.spieth-me.de/english/service-download/catalogue-instructions/
notice	Created: 13 Mar 2018/Fd	For any questions, requests or suggestions, please contact
ISO 16016	Checked: 13 Mar 2018/Ax	info@spieth-me.de

<p>Document Fehler! Verweisquelle konnte nicht gefunden werden.1815</p> <p>Page 6 of 11</p>	<h1>Operating Instructions</h1> <h2>MSR from M10 to M55</h2>	 <p>SPIETH Aus Prinzip präziser</p>
---	--	--

Incorrect handling or the use of inadequate aids can severely limit, damage, or destroy the machine element and/or the machine in its functionality.

Spieth locknuts are not meant to be repaired; if repairs are necessary in exceptional cases, only the manufacturer is allowed to perform them.

3 Delivery Contents and Storage of Spieth Locknuts

3.1 Delivery contents of the Spieth Locknuts

Spieth MSR series locknuts have been treated with a preservative. Within the component's packaging bag, a VCI atmosphere is created provided additional corrosion protection for a certain length of time. Opening the cover or withdrawing the component can reduce the duration of the corrosion protection even if the component is repackaged.

In case of complaints, please contact Spieth-Maschinenelemente GmbH & Co. KG with your multi-digit picking number at hand. In case you have to return the component, please package it with care, affix a shipping label, and send it to Spieth-Maschinenelemente GmbH & Co. KG.

If functional surfaces exhibit thin blank lines, then they have been created during our quality assurance process when measuring the components. They do not impact the functionality of the components and constitute no defects.

The clamping screws of Spieth locknuts have been tightened as ready for assembly.

3.2 Storage and shelf life of the Spieth Locknuts

In our experience, the corrosion protection is effective for up to two years, provided you keep the following in mind during the storage period:

- The storeroom is clean and enclosed
- Packaged parts are protected from mechanical influences
- The storeroom is dry (rel. humidity < 65%)
- The temperature range is 0°C to 40°C
- No corrosive media such as gases, vapors, or liquids can act

4 Assembling Spieth Locknuts

4.1 Preparing for assembly

Remove Spieth locknuts from their packaging right before assembly. As hand perspiration can cause corrosion, ensure to keep your hands dry and clean and/or to always wear protective gloves for assembly.

<p>©Spieth Proprietary notice ISO 16016</p>	<p>Previous document: ba-msrk-en1604 Successive document: N/A Created: 13 Mar 2018/Fd Checked: 13 Mar 2018/Ax</p>	<p>See www.spieth-me.de/english/service-download/catalogue-instructions/ For any questions, requests or suggestions, please contact info@spieth-me.de</p>
---	---	---

<p>Document Fehler! Verweisquelle konnte nicht gefunden werden.1815</p> <p>Page 7 of 11</p>	<h1>Operating Instructions</h1> <h2>MSR from M10 to M55</h2>	 <p>SPIETH Aus Prinzip präziser</p>
---	--	--

Please note:

For environmental reasons, please comply with applicable statutory regulations and guidelines when disposing of packaging materials.

In case of damage to packaging components, check the locknuts for damage and remove any contamination. The preservative used is compatible with all conventional machine oils. If in doubt, check the preservative's compatibility.

For an optimum mode of action of Spieth locknuts, remove the thin wax-like film of preservative from the contact surfaces using a lint-free cloth. Directly afterwards, use machine oil without friction-reducing additives to lightly oil the component and protect it from corrosion.

4.2 Ambience/Environment

During assembly, ensure that...

- the assembly location is clean and free from dust,
- the components have no contact with corrosive media,
- foreign bodies such as sand, sawdust, fluff, etc. are kept away from the component,
- metal filings (in particular from machining tools such as files, etc.) are kept away from the component.

Caution!

Contamination can significantly impact the functionality and service life of Spieth locknuts.

For best results, use a suitable, enclosed space for assembly and proceed swiftly. If this is not possible, make sure to protect the components from ambient contamination and from damage.

4.3 Assembly process

Essentially, assembly is a 4-step process:

- 1. Screwing
- 2. Aligning
- 3. Tightening
- 4. Locking

For an optimum mode of action of Spieth locknuts, perform all four assembly steps in the specified order.

Caution!

To apply the locking force, use only original Spieth clamping screws. Do not actuate the clamping screws until the nut thread has been fully screwed onto the spindle thread.

Otherwise, damage such as plastic deformation may occur on the locknut and render it unusable.

<p>©Spieth Proprietary notice ISO 16016</p>	<p>Previous document: ba-msrk-en1604 Successive document: N/A Created: 13 Mar 2018/Fd Checked: 13 Mar 2018/Ax</p>	<p>See www.spieth-me.de/english/service-download/catalogue-instructions/ For any questions, requests or suggestions, please contact info@spieth-me.de</p>
---	---	---

Document Fehler! Verweisquelle konnte nicht gefunden werden.1815 Page 8 of 11	<h1>Operating Instructions</h1> <h2>MSR from M10 to M55</h2>	 SPIETH Aus Prinzip präziser
--	--	---

Use only the following assembly process for assembling Spieth MSR series locknuts:

4.3.1 Screwing:

First clean, lightly oil and then screw the locknut onto the spindle thread but avoid contact with the end face. It is recommended to lightly oil the spindle thread, too. Since the nut thread is coordinated with the clearance of the spindle thread, you can easily do this manually. We recommend maintaining sufficient distance to the planar support while ensuring that the locking part of the nut body is fully screwed onto the spindle thread.

©Spieth Proprietary notice ISO 16016	Previous document: ba-msrk-en1604	See
	Successive document: N/A	www.spieth-me.de/english/service-download/catalogue-instructions/
	Created: 13 Mar 2018/Fd	For any questions, requests or suggestions, please contact
	Checked: 13 Mar 2018/Ax	info@spieth-me.de

Document Fehler! Verweisquelle konnte nicht gefunden werden.1815 Page 9 of 11	<h1>Operating Instructions</h1> <h2>MSR from M10 to M55</h2>	 Aus Prinzip präziser
--	--	--

4.3.2 Aligning:

Tighten the clamping screws stepwise and crosswise. Regularly check how much play the nut has on the thread. Repeat this process until the movement is nearly free of play. This aligns the end face of the locknut with the spindle axis. This requires very little torque on the clamping screws (normally far less than 1 Nm); we recommend using a manual tool (screwdriver or spanner) for sensitive tightening.

4.3.3 Tightening (1):

To reduce subsidence, first use an increased pretensioning torque M_{Ve} to tighten the locknut against the planar support; then undo it. Depending on the load capacity of the connecting components, the increased pretensioning torque M_{Ve} of the locknut may amount up to 1.2 to 1.5 times the calculated pretensioning torque M_V (see design guide/see note). When tightening via the axial mounting holes, the maximum permissible preload torque is limited to $M_{Ve} = 20 \text{ Nm}$ for sizes M10 and M12.

4.3.4 Tightening (2):

Now tighten the locknut with the calculated pretensioning torque M_V (see design guide/see notice) using a suitable tool (see design guide). When tightening via the axial mounting holes, the maximum permissible preload torque is limited to $M_V = 20 \text{ Nm}$ for sizes M10 and M12.

4.3.5 Locking:

Lock locknut by tightening the clamping screws stepwise and crosswise until the specified locking torque M_S (see design guide). For optimum effectiveness we recommend tightening the clamping screws in three steps (50%, 75% and 100% of the specified locking torque M_S). Due to the operating principle there may be a slight localised relief of strain of the contact on the end face but this has been factored into the calculated pretensioning torque M_V . Lock Spieth locknuts only if used with original Spieth clamping screws and if the nut thread is fully screwed onto the spindle thread.

In case of maximum demands on spindle concentricity you can individually adjust the clamping screws to achieve the desired result.

Please note:

Intense clamping at the thread flanks during the locking process causes a high level of axial rigidity on the locknut. In turn, this slightly reduces the pretension. The degree of this end face strain relief is reproducible and is easily compensated by the calculated pretensioning torque M_V (see design guide).

Following specified assembly, Spieth locknuts are ready for use immediately.

For more information on assembly, please see the relevant assembly instructions, available at www.spieth-me.de.

©Spieth Proprietary notice ISO 16016	Previous document: ba-msrk-en1604 Successive document: N/A Created: 13 Mar 2018/Fd Checked: 13 Mar 2018/Ax	See www.spieth-me.de/english/service-download/catalogue-instructions/ For any questions, requests or suggestions, please contact info@spieth-me.de
---	---	---

<p>Document Fehler! Verweisquelle konnte nicht gefunden werden.1815</p> <p>Page 10 of 11</p>	<h1>Operating Instructions</h1> <h2>MSR from M10 to M55</h2>	 <p>SPIETH Aus Prinzip präziser</p>
--	--	--

5 Using Spieth Locknuts

Spieth locknuts are maintenance-free. During general maintenance work, we nevertheless recommend a visual inspection. If used as intended, Spieth locknuts provide permanently precise pretension and positioning of the bearing on a threaded spindle.

We recommend periodic visual inspections of the locknut parts for potential damage. During regular maintenance intervals, check in particular locking torque M_s of the clamping screws.

Follow general safety notices when using Spieth locknuts.

Caution!

Never touch actively rotating components. Take protective measures against accidental contact.

If you notice irregularities with the Spieth locknuts during operation, immediately switch off the machine's drive.

6 Disassembling Spieth Locknuts

If handled correctly, Spieth locknuts can be reused several times. Due to the adjustments made, once a locknut has been locked onto a spindle thread you can only reuse it on the same thread after they have been disassembled.

Caution!

Unlock all the clamping screws stepwise and crosswise to avoid overstraining the screws. Otherwise, the screws may fracture or the locknut or its adjoining components may be damaged.

To disassemble, proceed in reverse assembly order.

- 1. Unlock: Unlock by undoing the clamping screws stepwise and crosswise.
- 2. Undo: Undo locknut from system using suitable tools.
- 3. Unscrew: Unscrew locknut by hand from threaded spindle.

If used as intended the diaphragm will open the interlocked thread flanks during unlocking. This restored joint play makes it easy to unscrew the locknut manually without damaging the threaded spindle.

Please note:

Following complete disassembly, slightly (manually) tighten the loosened clamping screws until they are flush. In any case, avoid tightening the clamping screws without a fully covered nut thread.

To enable later reuse, clean, preserve, and store Spieth locknuts correctly. Prior to reuse, proceed as detailed in section 4.1, "Preparing for assembly" ff.

©Spieth	Previous document: ba-msrk-en1604	See
Proprietary	Successive document: N/A	www.spieth-me.de/english/service-download/catalogue-instructions/
notice	Created: 13 Mar 2018/Fd	For any questions, requests or suggestions, please contact
ISO 16016	Checked: 13 Mar 2018/Ax	info@spieth-me.de

Document Fehler! Verweisquelle konnte nicht gefunden werden.1815 Page 11 of 11	<h1>Operating Instructions</h1> <h2>MSR from M10 to M55</h2>	 Aus Prinzip präziser
---	--	--

If non-original Spieth spare parts are used, Spieth-Maschinenelemente GmbH & Co. KG assumes no liability or warranty.

7 Disposing of Spieth Locknuts

You can easily reorder Spieth locknuts by entering the component designation imprinted on the nut body and the batch number.

Locknut body and clamping screws of a Spieth locknuts are made of steel. At the end of their operating life, clean metal parts and dispose of as scrap metal.

Please note:

For environmental reasons, please comply with applicable statutory regulations and guidelines when disposing of these products.

©Spieth Proprietary notice ISO 16016	Previous document: ba-msrk-en1604	See
	Successive document: N/A	www.spieth-me.de/english/service-download/catalogue-instructions/
	Created: 13 Mar 2018/Fd	For any questions, requests or suggestions, please contact
	Checked: 13 Mar 2018/Ax	info@spieth-me.de